

40W-320W HPJ Series Junction Box & LED Driver

INSTALLATION GUIDE



QUICK SPECS / MODELS

MODE	Constant Voltage
Input	100- 277 Vac
Voltage*	12V / 24V / 36V / 48V
Wattage	40-320 Watts

** Output Voltage*

SAFETY & WARNINGS

1. Read all instructions.
2. Install in accordance with national and local electrical code regulations.
3. This product is intended to be installed and serviced by a qualified, licensed electrician.
4. For cabinet and surface mount use only.
5. Indoor and outdoor use, in dry damp wet locations.
6. Do not conceal or extend exposed conductors through a building wall.
7. For low voltage exposed insulated conductor systems required by 30.1(c) of UL 2108 do not install any part of this system less than 7 feet (2.2m) above the floor.
8. To reduce the risk of fire and burns, do not install this lighting system where the exposed bare conductors can be shorted or contact any conductive materials.
9. Do not install any luminaire closer than 6 inches (15.25cm) from any curtain, or similar combustible materials.
10. Turn off electrical power before modifying the lighting system in any way.

AVERTISSEMENTS DE SÉCURITÉ

1. Lisez toutes les instructions.
2. Installez conformément aux réglementations nationales et locales du code électrique.
3. Ce produit est destiné à être installé et entretenu par un électricien qualifié et agréé.
4. Pour armoire et montage en surface uniquement.
5. Utilisation intérieure et extérieure, dans des endroits secs et humides.
6. Ne dissimulez pas et ne prolongez pas les conducteurs exposés à travers un mur de bâtiment.
7. Pour les systèmes de conducteurs isolés exposés à basse tension requis par 30.1(c) de la norme UL 2108, n'installez aucune partie de ce système à moins de 7 pieds (2,2 m) au-dessus du sol.
8. Pour réduire le risque d'incendie et de brûlures, n'installez pas ce système d'éclairage où les conducteurs nus exposés peuvent être court-circuités ou entrer en contact avec des matériaux conducteurs.
9. N'installez aucun luminaire à moins de 6 pouces (15,25 cm) d'un rideau ou de matériaux combustibles similaires.
10. Coupez l'alimentation électrique avant de modifier le système d'éclairage de quelque manière que ce soit.

40W-320W HPJ Series Junction Box & LED Driver INSTALLATION GUIDE

REQUIRED TOOLS

1



Hammer
Connectors

2



Screwdriver

3

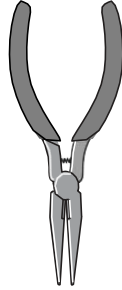

Pliers

4



Screws

5

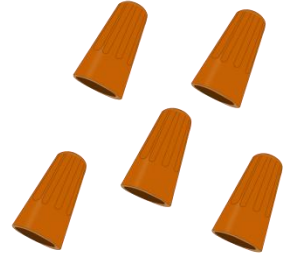

Twist-on Wire

INSTALLATION

STEP 1 TURN POWER OFF AT CIRCUIT BREAKER



SHOCK HAZARD! May result in serious injury or death.

Turn power OFF at circuit breaker prior to installation.

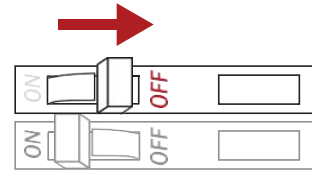

STEP 2 REMOVER SCREWS AND OPEN THE COVER

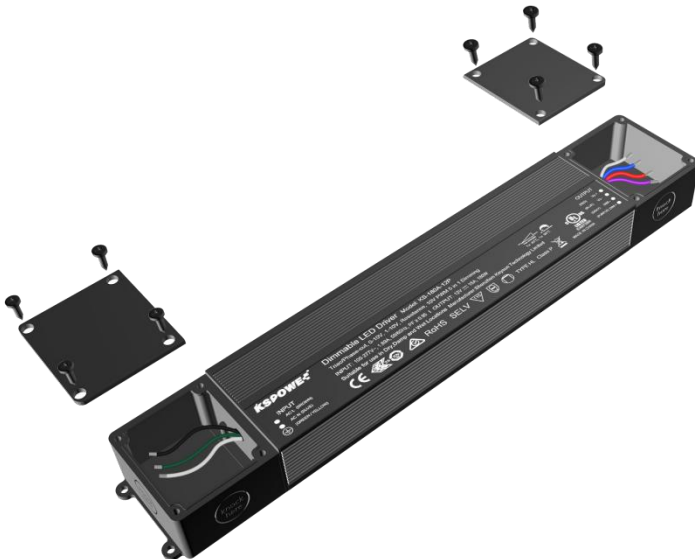

40W-320W HPJ Series Junction Box & LED Driver

INSTALLATION GUIDE

STEP 3 PUNCH OUT KNOCKOUTS FOR CONDUIT ACCESS

Use screwdriver and hammer to loosen knockout.

Grip knockout with pliers. Bend back and forth until broken off.

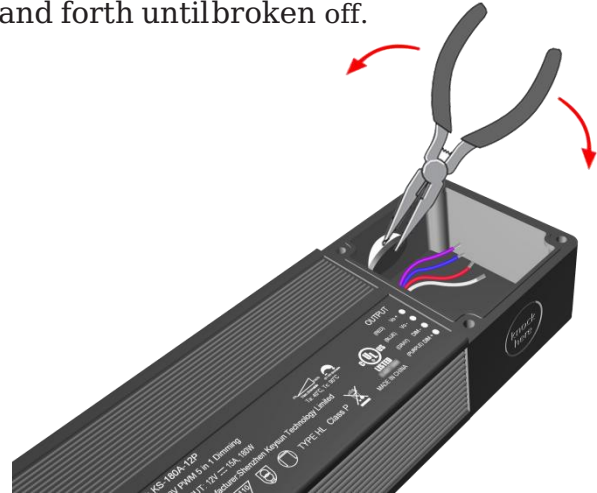

STEP 4 MOUNT DRIVER TO SURFACE

Mount screws into surface xxx inches apart horizontally and xxx inches vertically.

Fix the power supply on a horizontal surface with screws according to the fixing hole position

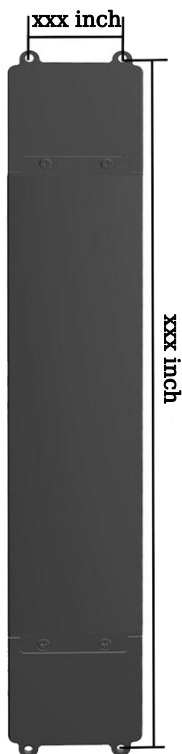

40W-320W HPJ Series Junction Box & LED Driver

INSTALLATION GUIDE

STEP 5 WIRE DRIVER TO AC INPUT AND LOW VOLTAGE LOAD

Wire LED Driver. *Ensure main power is OFF.*

1. GND*: Attach to J-Box and to Primary Ground
2. Neutral: To Primary High Voltage Neutral
3. Line (Hot): To Primary High Voltage Line Hot
4. V+: To Low Voltage Load V+
5. V-: To Low Voltage Load V-
6. Dim+: To Dimmer Signal (+)
7. Dim-: To Dimmer Signal (-)

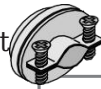

1/2" NON-METALLIC CABLE CONNECTOR

Confirm compliance of connector with Building Inspector.

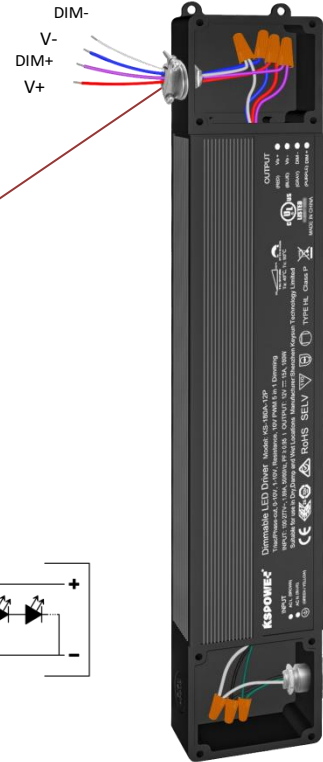

TRADITIONAL ON/OFF SYSTEM DIAGRAM

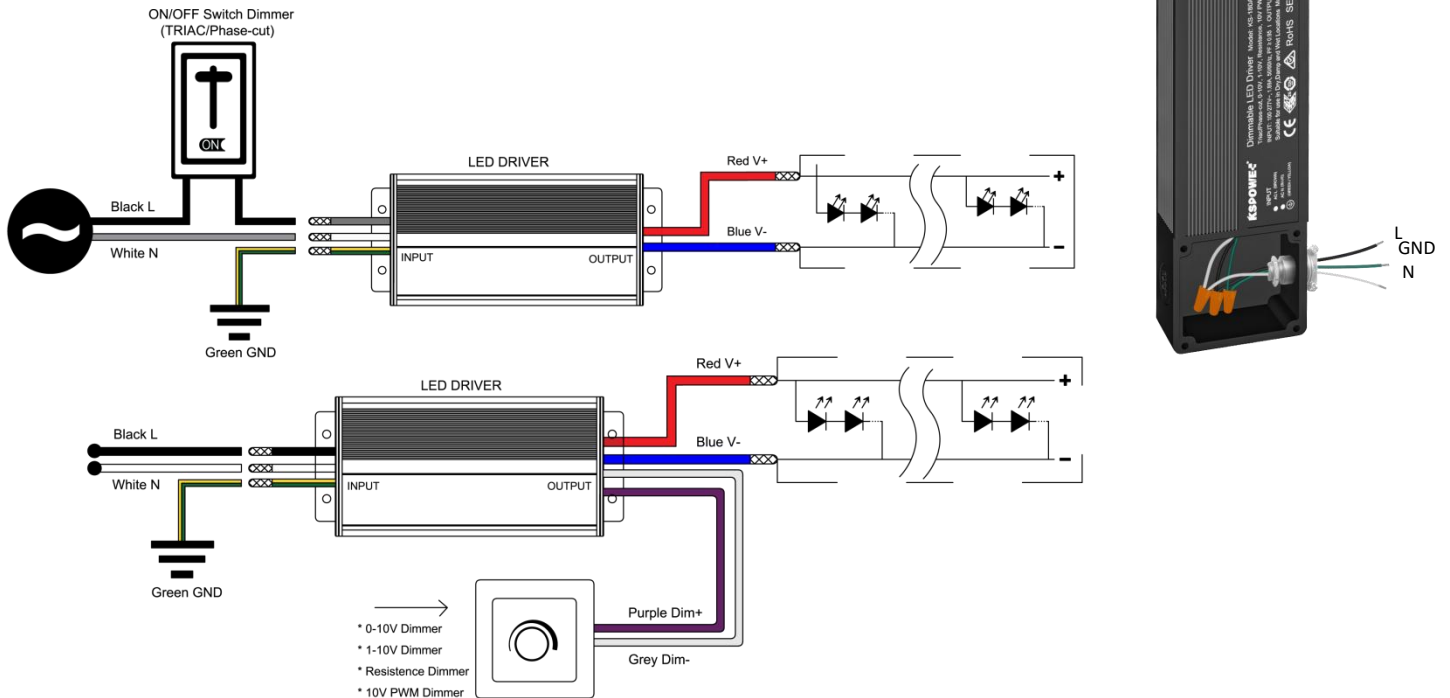

* *LED Driver and J-Box must be grounded in accordance with local and national electrical codes.* Ground the LED Driver and J-Box with the included Green Grounding Screw. Some compatible LED drivers are Class II certified and do not require a GF (Ground Fault Connection). Refer to the LED driver label and installation guide for more information.

STEP 6 TURN POWER ON AT CIRCUIT BREAKER

